

TOP ENTRY PCB JACK FCC-68 WIHT LEDS



7694 SERIES. Vertical PCB jack.

General Features

- Available in 8/8 circuits
- Standard telephone jack FCC-68
- 15.50 mm. height
- Accept standard plugs FCC-68
- Selective gold plating with different plating
- Bifurcated plastic foot print

Materials

- Insulator: Thermoplastic UL 94V-0
- Contact: 0.46 mm round in phosphor bronze
- Operating temperature. -25°C to + 85°C
- RoHS compliant

Dimensional Information

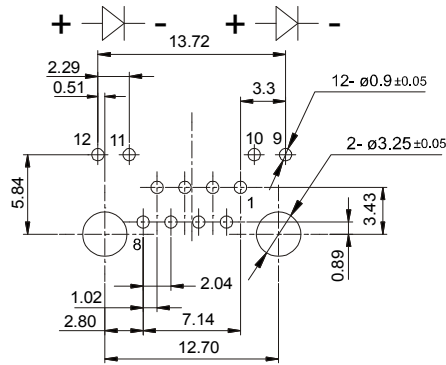
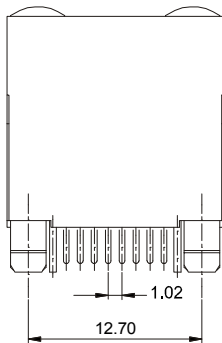
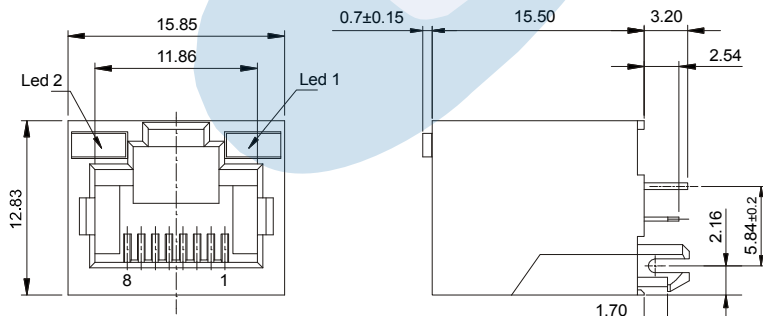
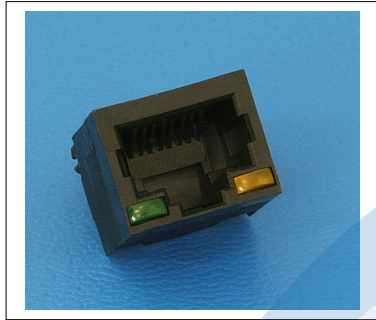

RECOMMENDED HOLE PATTERN

Electrical Features

- Voltage rating: < 125V
- Current rating: < 1.50 A
- Contact resistance: < 20 mΩ
- Dielectric withstanding voltage: 300 V AC/minute
- Insulation resistance: >1000 MΩ

Mechanical Features

- Durability: 1000 cycles

Circuit Size	Part Number
8/8	7694 – T88C

T = Plating Options

- T = 4. 6μ" gold over nickel
- T = 5. 15μ" gold over nickel
- T = 6. 30μ" gold over nickel
- T = 7. 50μ" gold over nickel

OPTION C	LED 1	LED 2
	RIGHT	LEFT
C = 0	W/O LED	W/O LED
C = 1	GREEN	YELLOW
C = 2	GREEN	W/O LED
C = 3	YELLOW	GREEN
C = 4	GREEN	GREEN
C = 5	YELLOW	YELLOW
C = 6	YELL/GREEN	YELL/GREEN
C = 7	GRREN/RED	GREEN/RED
C = 8	YELLOW	YELL/GREEN